

SERVICE MANUAL

© 2010-3 PRINTED IN JAPAN
 B53-0788-00 (N) 340

KDC-6047U : Panel assy (A64-5046-11)

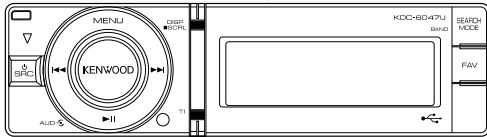

KDC-BT60U : Panel assy (A64-5045-11)

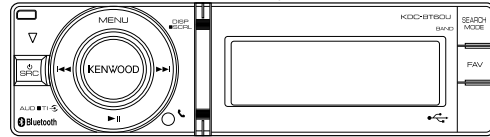

KDC-BT945U : Panel assy (A64-5042-11)

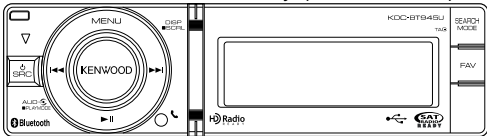

KDC-MP745U : Panel assy (A64-5044-11)

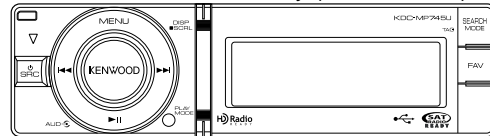

KDC-X7016/L : Panel assy (A64-5049-11)

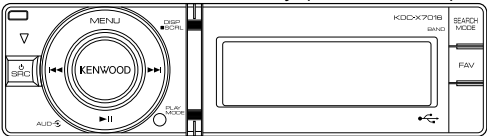

KDC-X794 : Panel assy (A64-5043-11)

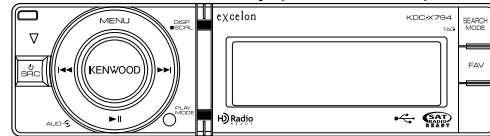

KDC-X8016BT/BTL : Panel assy (A64-5047-21)

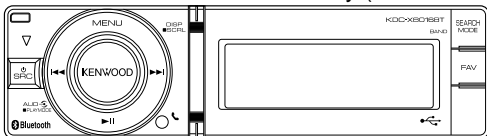

KDC-X994 : Panel assy (A64-5041-11)

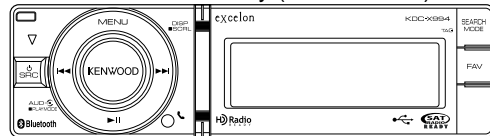

* Cover (F19-1475-04)



* Compact disc (W01-1778-05)

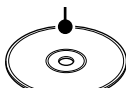

* Screw set (N99-1790-05)

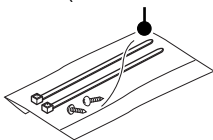

* Escutcheon (B07-xxxx-xx)

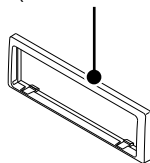

* Carrying case (W01-xxxx-xx)

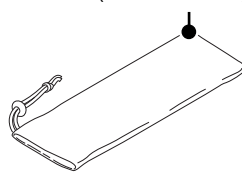

Mounting hardware assy (J22-0789-03)

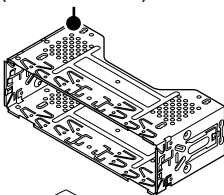

* DC cord (E30-6939-05)

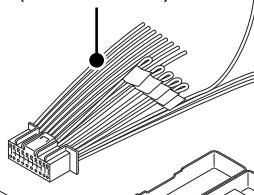

* DC cord (E30-6940-05)

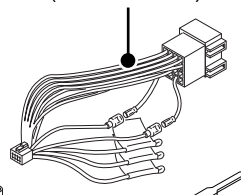

Remote controller assy (RC-405) (A70-2104-05)

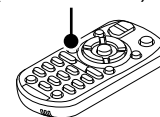

* Screw set (N99-1730-35)

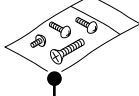

* Screw set (N99-1757-15)

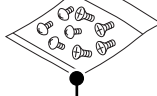

* Plastic cabinet assy (A02-2763-03)

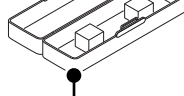

Lever (D10-7106-04) x2

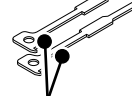

* Microphone (W01-1768-05)

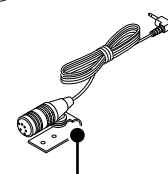

TDF SPARE-PANEL

MAIN UNIT NAME	TDF PARTS No.	TDF NAME
KDC-6047U	Y33-3302-72	TDF-6047U
KDC-BT60U	Y33-3302-71	TDF-BT60U
KDC-BT945U	Y33-3300-11	TDF-BT09D
KDC-MP745U	Y33-3300-13	TDF-MP07D
KDC-X7016	Y33-3300-23	TDF-X7016
KDC-X7016L	Y33-3300-24	TDF-X7016L
KDC-X794	Y33-1290-63	TDF-07DX
KDC-X8016BT	Y33-3300-21	TDF-X8016BT
KDC-X8016BTL	Y33-3300-22	TDF-X8016BTL
KDC-X994	Y33-1290-60	TDF-09DX

* Depends on the model. Refer to the parts list.



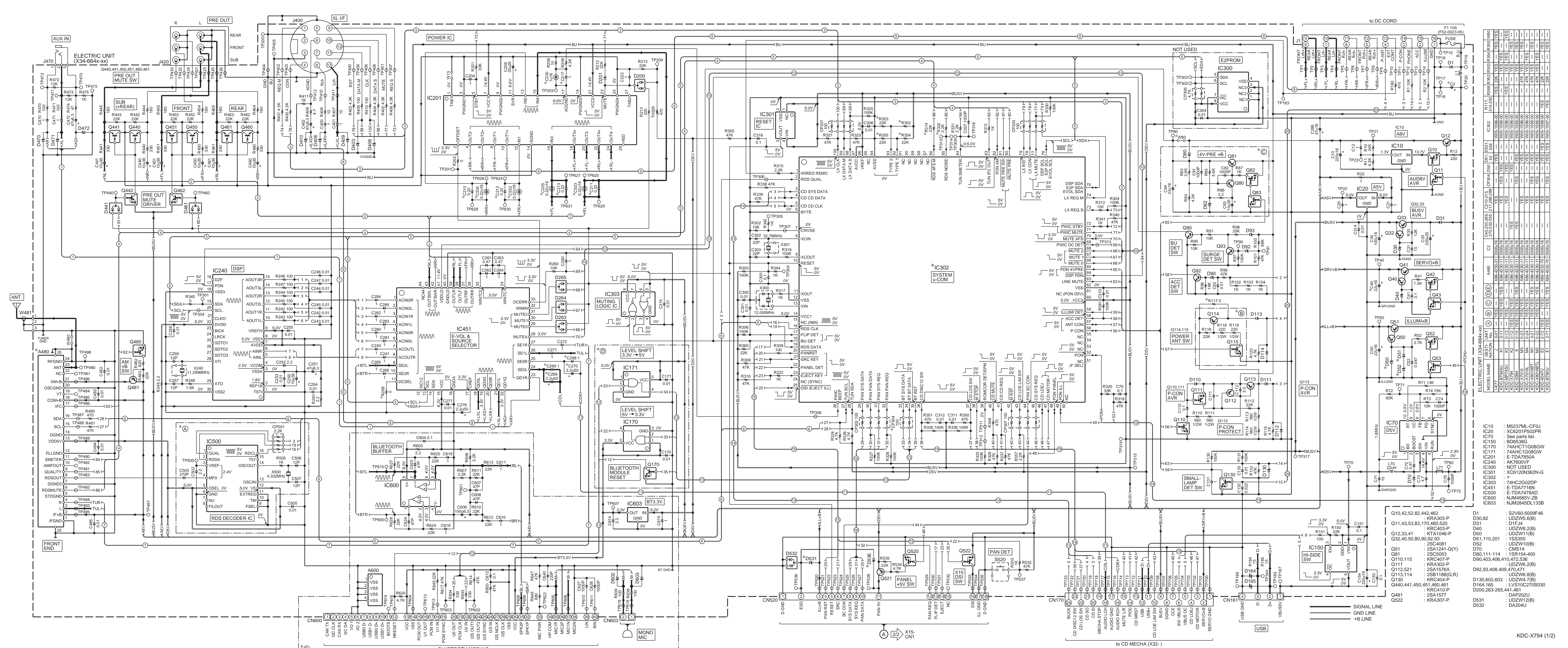

DESIGN	UNIT	NO.	QTY	UNIT	NO.	QTY	UNIT	NO.	QTY
IC10	M5237ML-CF0J								
IC20	XC6201P502PR								
IC70	See parts list								
IC150	B06530G								
IC170	74AHC11G08GW								
IC171	74AHC1G08GW								
IC201	E-TDA7850A								
IC240	AK7600VF								
IC451	E-TDA716N								
IC500	E-TDA7484D								
IC600	NJM4565V-ZB								
IC603	NJM2845DL133B								
D1	S2V60-5009F46								
D30.82	UDZV5.6(B)								
D31	D1FJ4								
D40	UDZW8.2(B)								
D50	UDZW11(B)								
D51, 110, 201	IS3355								
D52	2SC4081								
D70	CMS14								
D80, 111-114	1SR154-400								
D90, 403, 406, 410, 472, 536	UDZ46.2(B)								
D92, 93, 408, 409, 470, 471	IS3355								
D93	UDZW6.8(B)								
Q81	2SC5053								
Q110, 115	KRC407-P								
Q111	KRA302-P								
Q112, 521	2SA1576A								
Q113, 114	2SB1188(Q,R)								
Q130	KRC404-P								
Q440, 441, 450, 451, 460, 461	UDZ46.2(B)								
Q481	KSA1577								
Q522	KRA307-P								

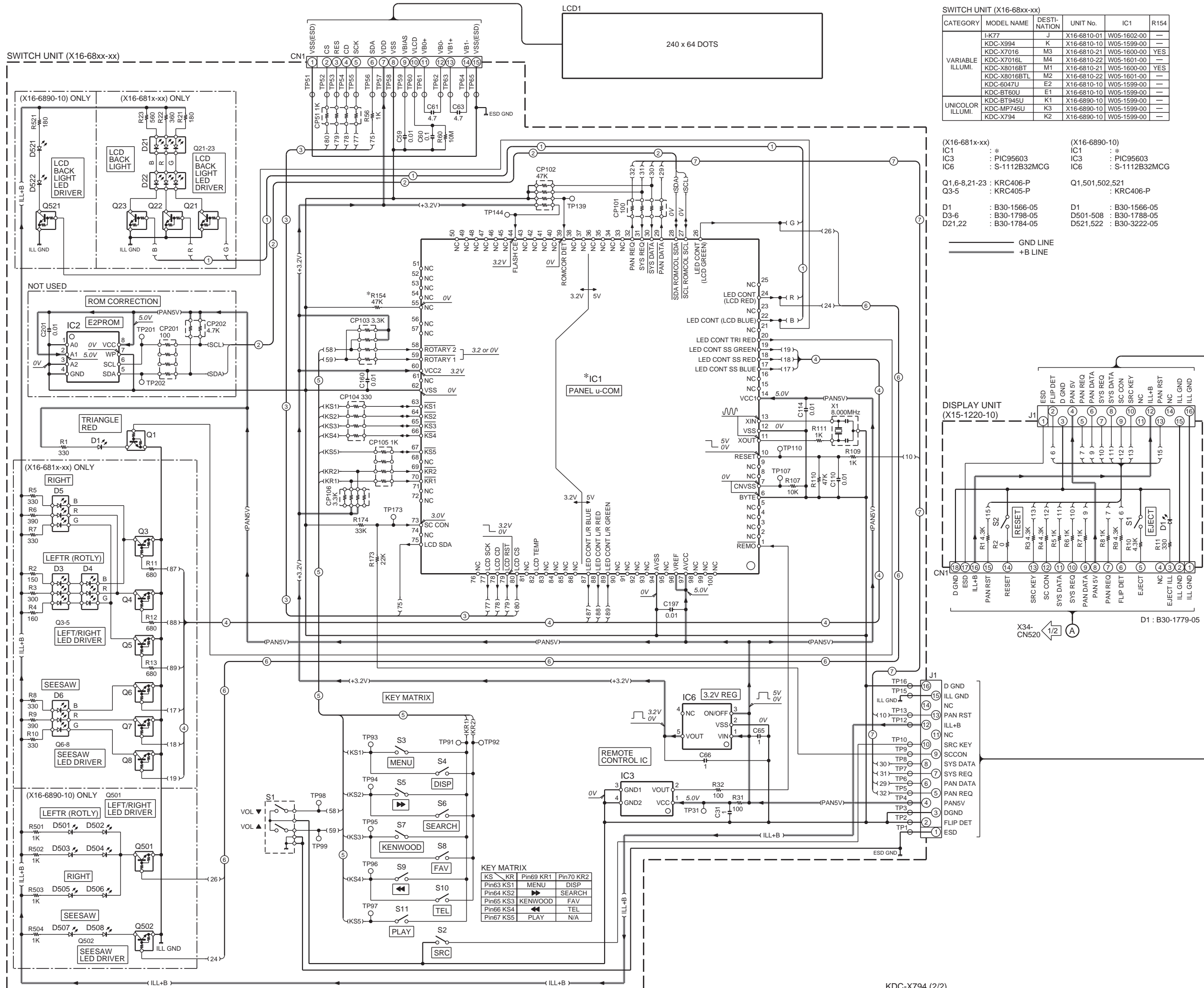

SWITCH UNIT (X16-68xx-xx)

CATEGORY	MODEL NAME	DESTINATION	UNIT No.	IC1	R154
VARIABLE ILLUMI.	I-K77	J	X16-6810-01	W05-1602-00	—
	KDC-X984	K	X16-6810-10	W05-1599-00	—
	KDC-X7016	M3	X16-6810-21	W05-1600-00	YES
	KDC-X7016L	M4	X16-6810-22	W05-1601-00	—
	KDC-X8016BT	M1	X16-6810-21	W05-1600-00	YES
	KDC-X8016BTL	M2	X16-6810-22	W05-1601-00	—
UNICOLOR ILLUMI.	KDC-6047U	E2	X16-6810-10	W05-1599-00	—
	KDC-BT60U	E1	X16-6810-10	W05-1599-00	—
	KDC-BT945U	K1	X16-6890-10	W05-1599-00	—
	KDC-MP745U	K3	X16-6890-10	W05-1599-00	—
KDC-X794	K2	X16-6890-10	W05-1599-00	—	

(X16-681x-xx) IC1 : * IC3 : PIC95603 IC6 : S-1112B32MCG
 (X16-6890-10) IC1 : * IC3 : PIC95603 IC6 : S-1112B32MCG

Q1,6-8,21-23 : KRC406-P Q1,501,502,521
 Q3-5 : KRC405-P : KRC406-P

D1 : B30-1566-05 D1 : B30-1566-05
 D3-6 : B30-1798-05 D501-508 : B30-1788-05
 D21,22 : B30-1784-05 D521,522 : B30-3222-05

— GND LINE
 — +B LINE

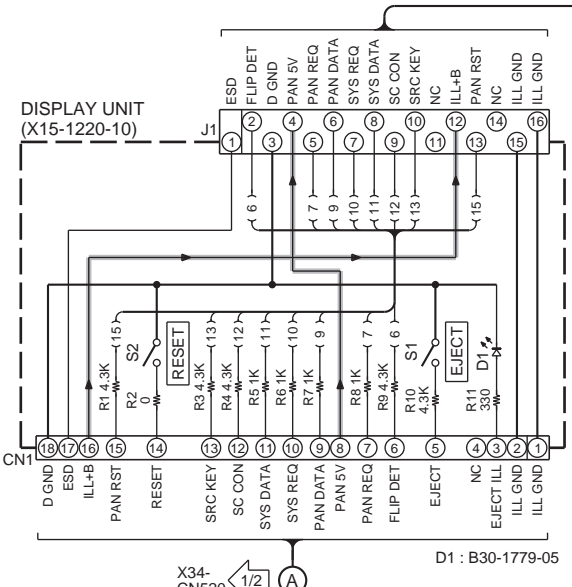

D1 : B30-1779-05

-B 0.5P (CAR : 2pt 6/3 30%BLACK)
 1 1P (HOME : 1.5pt)
 2 0.5P (CAR : 2pt 30%BLACK)

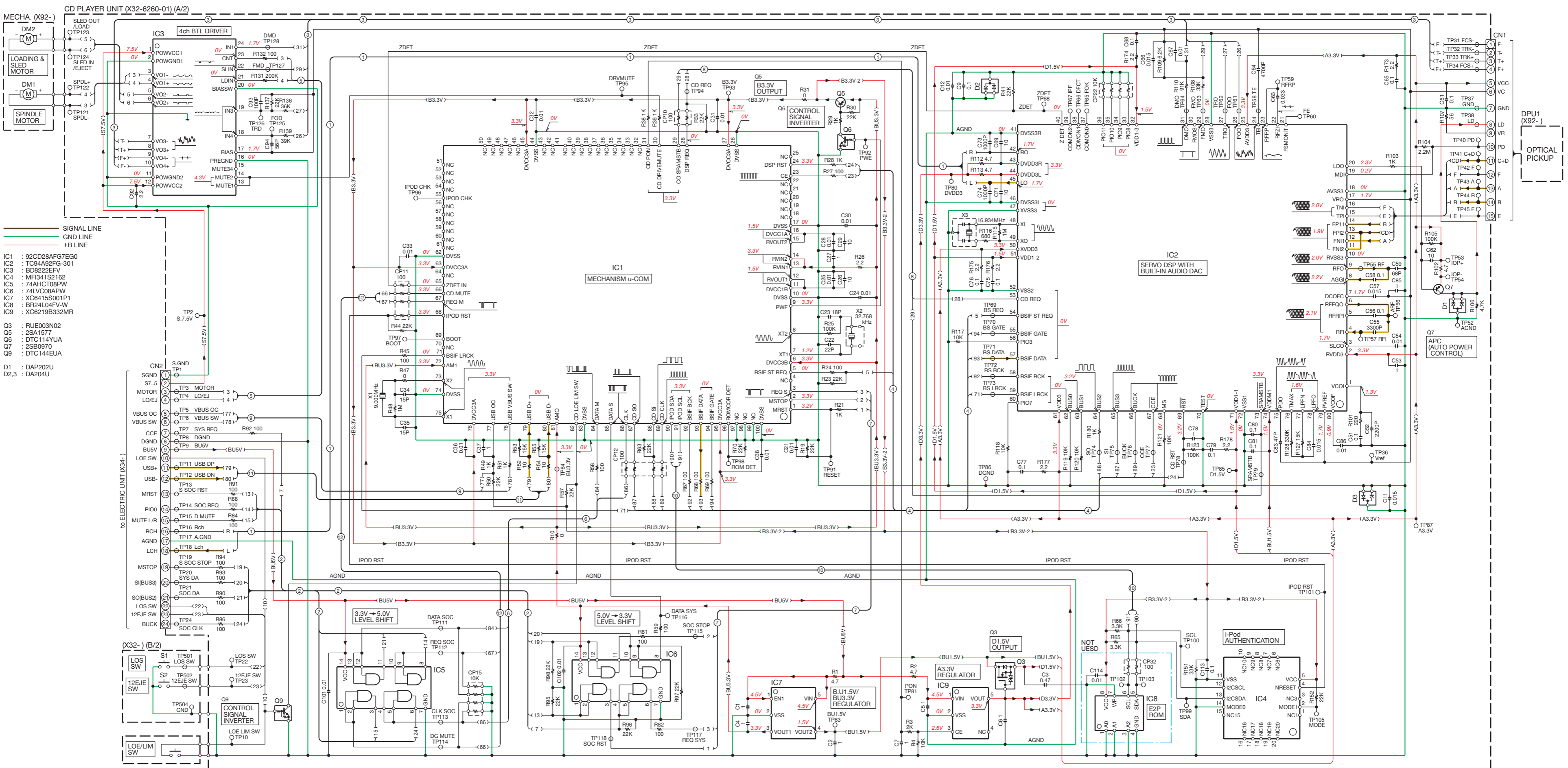

A

B

- A : N09-6108-15
- B : N09-6426-15
- C : N09-6735-05
- D : N09-6737-15
- E : N09-6738-15
- F : N19-2335-14
- G : N35-2003-48
- H : N39-1720-48

1

2

3

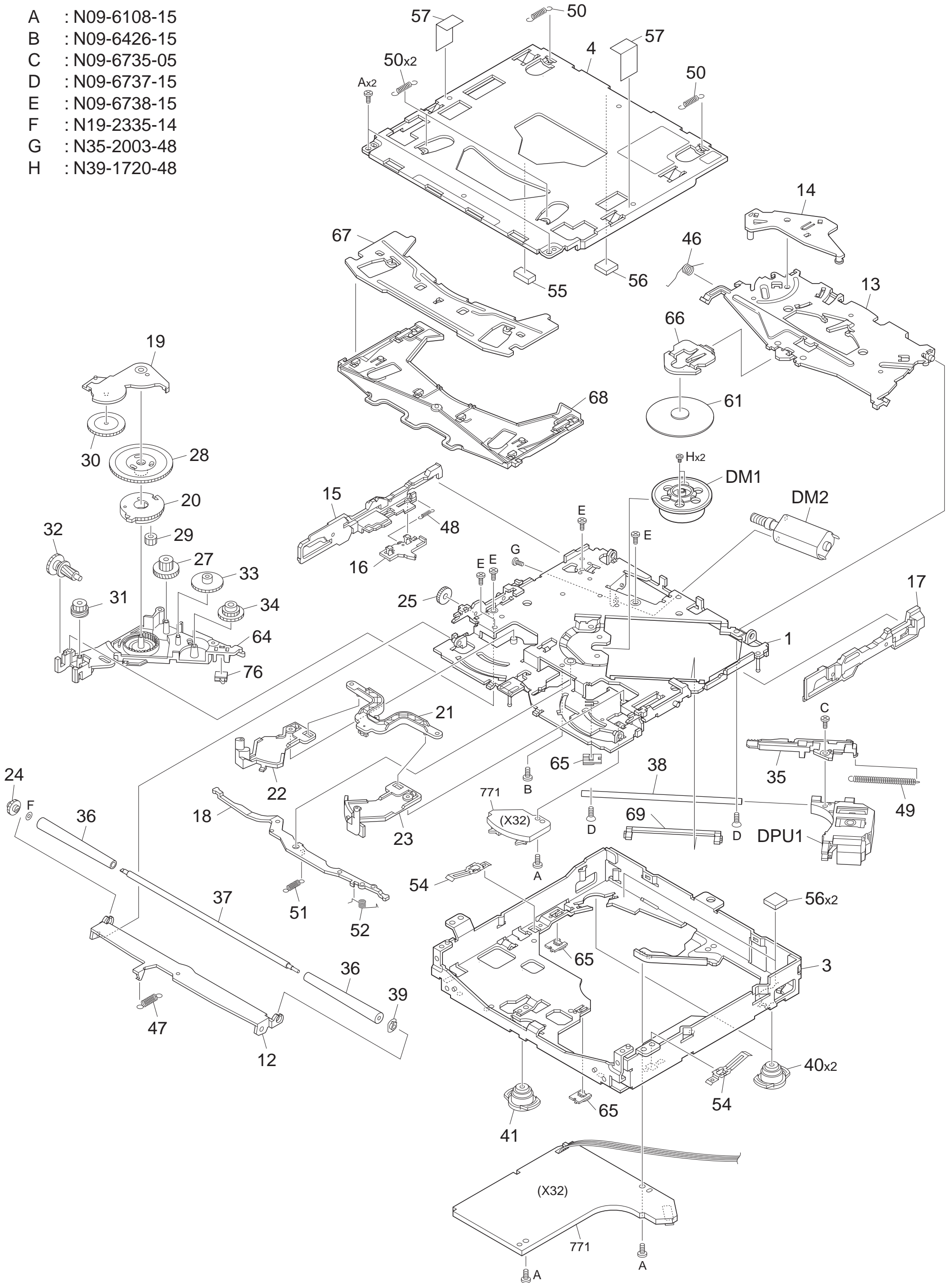

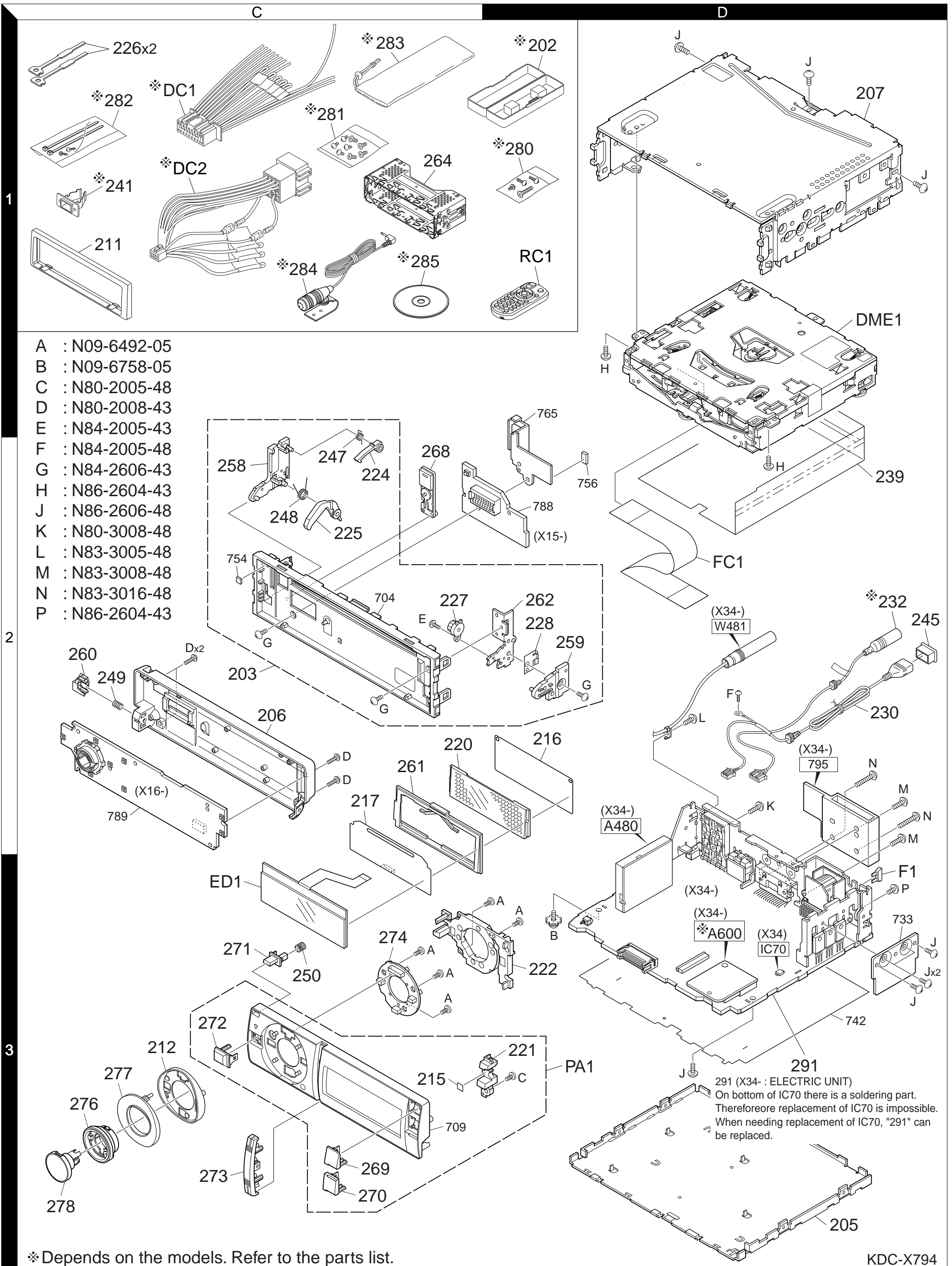

PARTS LIST

* New parts

Parts without **Parts No.** are not supplied.

Les articles non mentionnés dans le **Parts No.** ne sont pas fournis.

Teile ohne **Parts No.** werden nicht geliefert.

Ref.No.	A d d	N e w	Parts No.	Description	Dest inati on	Ref.No.	A d d	N e w	Parts No.	Description	Dest inati on
KDC-6047U/BT60U/BT945U/MP745U/X7016/X794/X8016BT/X994						239	2D		F11-1874-03	SHIELDING COVER	
202	1D	*	A02-2763-03	PLASTIC CABINET ASSY	M1M2M3	241	1C		F19-1475-04	COVER	KK2
202	1D	*	A02-2763-03	PLASTIC CABINET ASSY	M4	245	2D		F29-0637-04	INSULATING COVER	
203	2C		A22-3218-02	SUB PANEL ASSY		F1	3D		F52-0023-05	FUSE (MINI BLADE TYPE) (10A)	
205	3D	*	A40-1365-12	BOTTOM PLATE		247	2C		G01-3171-04	TORSION COIL SPRING	
206	2C	*	A46-1905-01	REAR COVER		248	2C		G01-3172-04	TORSION COIL SPRING	
207	1D		A52-1111-01	TOP COVER		249	2C		G01-3173-04	COMPRESSION SPRING	
PA1	3D	*	A64-5041-11	PANEL ASSY	K	250	3C		G01-3203-04	COMPRESSION SPRING	
PA1	3D	*	A64-5042-11	PANEL ASSY	K1			*	H54-4783-03	ITEM CARTON CASE	K
PA1	3D	*	A64-5043-11	PANEL ASSY	K2			*	H54-4784-03	ITEM CARTON CASE	K1
PA1	3D	*	A64-5044-11	PANEL ASSY	K3			*	H54-4785-03	ITEM CARTON CASE	K2
PA1	3D	*	A64-5045-11	PANEL ASSY	E1			*	H54-4786-03	ITEM CARTON CASE	K3
PA1	3D	*	A64-5046-11	PANEL ASSY	E2			*	H54-4787-03	ITEM CARTON CASE	E1
PA1	3D	*	A64-5047-21	PANEL ASSY	M1M2			*	H54-4788-03	ITEM CARTON CASE	E2
PA1	3D	*	A64-5049-11	PANEL ASSY	M3M4			*	H54-4789-03	ITEM CARTON CASE	M1
RC1	1D		A70-2104-05	REMOTE CONTROLLER ASSY (RC-405)				*	H54-4790-03	ITEM CARTON CASE	M2
-		*	B59-2009-00	SUB-INST. MANUAL (ENG.FRE.SPA.)	KK1K2			*	H54-4791-03	ITEM CARTON CASE	M3
-		*	B59-2009-00	SUB-INST. MANUAL (ENG.FRE.SPA.)	K3			*	H54-4792-03	ITEM CARTON CASE	M4
-		*	B59-2010-00	SUB-INST. MANUAL (ENG.FRE.)	E1E2	258	2C		J19-5203-03	HOLDER (LEFT)	
-		*	B59-2010-00	SUB-INST. MANUAL (GER.DUT.)	E1E2	259	2D		J19-5204-03	HOLDER (RIGHT)	
-		*	B59-2011-00	SUB-INST. MANUAL (ITA.SPA.POR.)	E1E2	260	2C		J19-5205-03	HOLDER (REAR COVER)	
-		*	B59-2011-00	SUB-INST. MANUAL (RUS.URK.)	E1E2	261	2C		J19-7252-03	HOLDER	
-		*	B59-2012-00	SUB-INST. MANUAL (ENGLISH)	M1M2M3	262	2D		J21-9977-03	MOUNTING HARDWARE (DUMPER BASE)	
-		*	B59-2012-00	SUB-INST. MANUAL (S-CHI.ARA.)	M4	264	1C		J22-0789-03	MOUNTING HARDWARE ASSY	
-		*	B64-4520-00	INST. MANUAL (ENGLISH)	M1M2M3	268	2C		K24-4995-03	PUSH KNOB (EJECT)	
-		*	B64-4520-00	INST. MANUAL (ENGLISH)	M4	269	3C	*	K24-5057-13	PUSH KNOB (SEARCH MODE)	KK2M1
-		*	B64-4521-00	INST. MANUAL (S-CHINESE)	M1M3	269	3C	*	K24-5057-13	PUSH KNOB (SEARCH MODE)	M2
-		*	B64-4522-00	INST. MANUAL (ARABIC)	M2M4	269	3C	*	K24-5058-13	PUSH KNOB (SEARCH MODE)	E2M3M
211	1C		B07-3235-03	ESCUTCHEON	KK2M1	269	3C	*	K24-5058-13	PUSH KNOB (SEARCH MODE)	K1K3E
211	1C		B07-3235-03	ESCUTCHEON	M2	270	3C	*	K24-5059-03	PUSH KNOB (FAV)	KK2M1
211	1C		B07-3304-03	ESCUTCHEON	E2M3M4	270	3C	*	K24-5059-03	PUSH KNOB (FAV)	M2
211	1C		B07-3304-03	ESCUTCHEON	K1K3E1	270	3C	*	K24-5060-03	PUSH KNOB (FAV)	E2M3M
212	3C	*	B07-3338-03	ESCUTCHEON (MENU)		270	3C	*	K24-5060-03	PUSH KNOB (FAV)	K1K3E
215	3C	*	B11-2016-04	REFLECTION SHEET		271	3C	*	K24-5062-04	PUSH KNOB (RELEASE)	
216	2D		B11-2027-04	REFLECTION SHEET		272	3C	*	K24-5068-03	PUSH KNOB (SRC)	
217	2C		B11-2028-04	OPTICAL DIFFUSER		273	3C	*	K25-1988-03	PUSH KNOB (SPEED SEARCH)	
220	2C		B19-2535-03	LIGHTING BOARD		274	3C	*	K28-0403-13	KNOB BASE (MENU)	
221	3D	*	B19-2562-03	LIGHTING BOARD (R)		276	3C	*	K28-0407-14	KNOB ASSY (VOL)	
222	3D	*	B19-2563-02	LIGHTING BOARD (L)		277	3C	*	K28-0418-03	KEY TOP (MENU)	
ED1	3C	*	B38-1224-05	LCD (240 X 64 DOTS)		278	3C	*	K28-0422-04	KNOB ASSY (KENWOOD)	
224	2C		D10-4730-03	LEVER		280	1D		N99-1730-35	SCREW SET	KK1K2
225	2C		D10-4731-03	LEVER		280	1D		N99-1730-35	SCREW SET	K3M1M
226	1C		D10-7106-04	LEVER (ACCESSORY)		280	1D		N99-1730-35	SCREW SET	M3M4
227	2C		D39-0255-05	DAMPER		281	1C		N99-1757-15	SCREW SET	KK1K2
228	2D		E29-2136-04	LEAD PLATE		281	1C		N99-1757-15	SCREW SET	K3M1M
230	2D	*	E30-6943-05	CORD WITH CONNECTOR (USB)		281	1C		N99-1757-15	SCREW SET	M3M4
232	2D		E30-6907-05	CORD WITH CONNECTOR (MIC)	KK1E1	282	1C		N99-1790-05	SCREW SET	KK2
232	2D		E30-6907-05	CORD WITH CONNECTOR (MIC)	M1M2	A	3C		N09-6492-05	TAPTITE SCREW	
DC1	1C	*	E30-6939-05	DC CORD	KK1K2	B	3D		N09-6758-05	TAPTITE SCREW	
DC1	1C	*	E30-6939-05	DC CORD	K3M1M2	C	3C		N80-2005-48	PAN HEAD TAPTITE SCREW	
DC1	1C	*	E30-6939-05	DC CORD	M3M4	D	2C		N80-2008-43	PAN HEAD TAPTITE SCREW	
DC2	1C	*	E30-6940-05	DC CORD	E1E2	E	2C		N84-2005-43	PAN HEAD TAPTITE SCREW	
FC1	2D		E39-1104-05	FLAT CABLE		F	2D		N84-2005-48	PAN HEAD TAPTITE SCREW	

K: KDC-X994 K1: KDC-BT945U K2: KDC-X794 K3: KDC-MP745U M1: KDC-X8016BT

M2: KDC-X8016BTL M3: KDC-X7016 M4: KDC-X7016L E1: KDC-BT60U E1: KDC-6047U

⚠ indicates safety critical components.

PARTS LIST

Ref.No.	A d d	N e w	Parts No.	Description	Dest inati on	Ref.No.	A d d	N e w	Parts No.	Description	Dest inati on
G	2C		N84-2606-43	PAN HEAD TAPTITE SCREW		C160			CK73GB1H103K	CHIP C 0.010UF K	
H	1D		N86-2604-43	BINDING HEAD TAPTITE SCREW		C197			CK73GB1H103K	CHIP C 0.010UF K	
J	1D		N86-2606-48	BINDING HEAD TAPTITE SCREW		CN1			E41-3094-05	FLAT CABLE CONNECTOR	
283	1C		W01-1664-05	CARRYING CASE (EXCELON)	KK2	J1			E59-0850-05	RECTANGULAR PLUG	
283	1C		W01-1710-05	CARRYING CASE	E2				L78-1409-05	RESONATOR (8MHZ)	
283	1C		W01-1710-05	CARRYING CASE	K1K3E1	X1					
284	1C		W01-1768-05	MICROPHONE	KK1E1						
284	1C		W01-1768-05	MICROPHONE	M1M2	CP51			RK74HB1J102J	CHIP-COM 1.0K J 1/16W	
285	1C	*	W01-1778-05	COMPACT DISC (INST. MANUAL)	KK1K2	CP101			RK74HB1J101J	CHIP-COM 100 J 1/16W	
285	1C	*	W01-1778-05	COMPACT DISC (INST. MANUAL)	K3E1E2	CP102			RK74HB1J473J	CHIP-COM 47K J 1/16W	
291	3D	*	X34-6640-10	ELECTRIC UNIT (For IC70)	K	CP103			RK74HB1J332J	CHIP-COM 3.3K J 1/16W	
291	3D	*	X34-6640-11	ELECTRIC UNIT (For IC70)	K1	CP104			RK74HB1J331J	CHIP-COM 330 J 1/16W	
291	3D	*	X34-6640-12	ELECTRIC UNIT (For IC70)	K2	CP105			RK74HB1J102J	CHIP-COM 1.0K J 1/16W	
291	3D	*	X34-6640-13	ELECTRIC UNIT (For IC70)	K3	CP106			RK74HB1J332J	CHIP-COM 3.3K J 1/16W	
291	3D	*	X34-6640-21	ELECTRIC UNIT (For IC70)	M1	R1			RK73GB2A331J	CHIP R 330 J 1/10W	
291	3D	*	X34-6640-22	ELECTRIC UNIT (For IC70)	M2	R2			RK73EB2E151J	CHIP R 150 J 1/4W	KE1E2
291	3D	*	X34-6640-23	ELECTRIC UNIT (For IC70)	M3	R2			RK73EB2E151J	CHIP R 150 J 1/4W	M1M2M
291	3D	*	X34-6640-24	ELECTRIC UNIT (For IC70)	M4	R2			RK73EB2E301J	CHIP R 150 J 1/4W	M4
291	3D	*	X34-6642-71	ELECTRIC UNIT (For IC70)	E1	R3			RK73EB2E301J	CHIP R 300 J 1/4W	KE1E2
291	3D	*	X34-6642-72	ELECTRIC UNIT (For IC70)	E2	R3			RK73EB2E301J	CHIP R 300 J 1/4W	M1M2M
DME1	1D		X92-6360-04	MECHANISM ASSY (DXM-9B34W)		R3			RK73EB2E301J	CHIP R 300 J 1/4W	M4
SWITCH UNIT (X16-68xx-xx)						R4			RK73EB2E161J	CHIP R 160 J 1/4W	KE1E2
D1			B30-1779-05	LED (1608,SR)		R4			RK73EB2E161J	CHIP R 160 J 1/4W	M1M2M
CN1			E41-2984-05	PIN ASSY		R5			RK73EB2E331J	CHIP R 330 J 1/4W	M4
J1			E58-1008-05	RECTANGULAR RECEPTACLE		R5			RK73EB2E331J	CHIP R 330 J 1/4W	KE1E2
R1			RK73EB2E432J	CHIP R 4.3K J 1/4W		R5			RK73EB2E331J	CHIP R 330 J 1/4W	M1M2M
R2			RK73EB2E000J	CHIP R 0.0 J 1/4W		R5			RK73EB2E331J	CHIP R 330 J 1/4W	M4
R3 ,4			RK73EB2E432J	CHIP R 4.3K J 1/4W		R6			RK73EB2E391J	CHIP R 390 J 1/4W	KE1E2
R5 -8			RK73EB2E102J	CHIP R 1.0K J 1/4W		R6			RK73EB2E391J	CHIP R 390 J 1/4W	M1M2M
R9 ,10			RK73EB2E432J	CHIP R 4.3K J 1/4W		R6			RK73EB2E391J	CHIP R 390 J 1/4W	M4
R11			RK73FB2B331J	CHIP R 330 J 1/8W		R7 ,8			RK73EB2E331J	CHIP R 330 J 1/4W	KE1E2
S1			S70-0901-05	TACT SWITCH		R7 ,8			RK73EB2E331J	CHIP R 330 J 1/4W	M1M2M
S2			S70-0948-05	TACT SWITCH		R7 ,8			RK73EB2E331J	CHIP R 330 J 1/4W	M4
D1			B30-1566-05	LED (1608,RED)		R9			RK73EB2E391J	CHIP R 390 J 1/4W	KE1E2
D3 -6			B30-1798-05	LED(RGB MPX A,B,C,D)	KE1E2	R9			RK73EB2E391J	CHIP R 390 J 1/4W	M1M2M
D3 -6			B30-1798-05	LED (RGB MPX A,B,C,D)	M1M2M3	R9			RK73EB2E391J	CHIP R 390 J 1/4W	M4
D3 -6			B30-1798-05	LED (RGB MPX A,B,C,D)	M4	R9			RK73EB2E391J	CHIP R 390 J 1/4W	KE1E2
D21 ,22			B30-1784-05	LED (RGB SIDE)	KE1E2	R9			RK73EB2E391J	CHIP R 390 J 1/4W	M1M2M
D21 ,22			B30-1784-05	LED (RGB SIDE)	M1M2M3	R9			RK73EB2E391J	CHIP R 390 J 1/4W	M4
D21 ,22			B30-1784-05	LED (RGB SIDE)	M4	R9			RK73EB2E391J	CHIP R 390 J 1/4W	KE1E2
D501-508			B30-1788-05	LED (1608,WHITE)	K1K2K3	R9			RK73EB2E391J	CHIP R 390 J 1/4W	M1M2M
D521,522		*	B30-3222-05	LED	K1K2K3	R10			RK73EB2E331J	CHIP R 330 J 1/4W	M4
C31			CK73GB1A105K	CHIP C 1.0UF K		R10			RK73EB2E331J	CHIP R 330 J 1/4W	KE1E2
C59			CK73GB1H103K	CHIP C 0.010UF K		R10			RK73EB2E331J	CHIP R 330 J 1/4W	M1M2M
C60			CK73GB1H104K	CHIP C 0.10UF K		R11 -13			RK73GB2A681J	CHIP R 680 J 1/10W	M4
C61			CK73GB0J475K	CHIP C 4.7UF K		R11 -13			RK73GB2A681J	CHIP R 680 J 1/10W	KE1E2
C63			CK73GB0J475K	CHIP C 4.7UF K		R11 -13			RK73GB2A681J	CHIP R 680 J 1/10W	M1M2M
C65 ,66			CK73GB1A105K	CHIP C 1.0UF K		R21			RK73EB2E181J	CHIP R 180 J 1/4W	M4
C110			CK73GB1H103K	CHIP C 0.010UF K		R21			RK73EB2E181J	CHIP R 180 J 1/4W	KE1E2
C114			CK73GB1H103K	CHIP C 0.010UF K		R21			RK73EB2E181J	CHIP R 180 J 1/4W	M1M2M
						R21			RK73EB2E181J	CHIP R 180 J 1/4W	M4
						R22			RK73EB2E361J	CHIP R 360 J 1/4W	KE1E2
						R22			RK73EB2E361J	CHIP R 360 J 1/4W	M1M2M
						R22			RK73EB2E361J	CHIP R 360 J 1/4W	M4
						R23			RK73EB2E561J	CHIP R 560 J 1/4W	KE1E2
						R23			RK73EB2E561J	CHIP R 560 J 1/4W	M1M2M
						R23			RK73EB2E561J	CHIP R 560 J 1/4W	M4
						R31 ,32			RK73GB2A101J	CHIP R 100 J 1/10W	
						R56			RK73GB2A102J	CHIP R 1.0K J 1/10W	
						R60			RK73GB2A106J	CHIP R 10M J 1/10W	
						R107			RK73GB2A103J	CHIP R 10K J 1/10W	

K: KDC-X994 K1: KDC-BT945U K2: KDC-X794 K3: KDC-MP745U M1: KDC-X8016BT
M2: KDC-X8016BTL M3: KDC-X7016 M4: KDC-X7016L E1: KDC-BT60U E1: KDC-6047U

⚠ indicates safety critical components.

PARTS LIST

SWITCH UNIT (X16-68xx-xx)

Ref.No.	A d d	N e w	Parts No.	Description	Dest inati on	Ref.No.	A d d	N e w	Parts No.	Description	Dest inati on
R109			RK73GB2A102J	CHIP R 1.0K J 1/10W		C56			CK73GB1C104K	CHIP C 0.10UF K	
R110			RK73GB2A473J	CHIP R 47K J 1/10W		C57			CK73GB1H153K	CHIP C 0.015UF K	
R111			RK73GB2A102J	CHIP R 1.0K J 1/10W		C58			CK73GB1C104K	CHIP C 0.10UF K	
R154			RK73GB2A473J	CHIP R 47K J 1/10W	M1M3	C59			CC73GCH1H680J	CHIP C 68PF J	
R173			RK73GB2A223J	CHIP R 22K J 1/10W		C61			CK73GB1C104K	CHIP C 0.10UF K	
R174			RK73GB2A333J	CHIP R 33K J 1/10W		C62			CK73FB0J106K	CHIP C 10UF K	
R501-504			RK73FB2B102J	CHIP R 1.0K J 1/8W	K1K2K3	C63			CK73GB1H333K	CHIP C 0.033UF K	
R521			RK73EB2E181J	CHIP R 180 J 1/4W	K1K2K3	C64			CK73GB1H472K	CHIP C 4700PF K	
S2 -11	*		S70-0960-05	TACT SWITCH		C65			CK73GB1C104K	CHIP C 0.10UF K	
S1	*		T99-0488-05	ROTARY ENCODER		C66			CK73GB1H153K	CHIP C 0.015UF K	
IC1	*		W05-1599-00	MICROCONTROLLER IC	E1E2K	C67			CK73GB1H103K	CHIP C 0.010UF K	
IC1	*		W05-1599-00	MICROCONTROLLER IC	K1K2K3	C68			CK73GB1C104K	CHIP C 0.10UF K	
IC1	*		W05-1600-00	MICROCONTROLLER IC	M1M3	C69			CK73FB0J106K	CHIP C 10UF K	
IC1	*		W05-1601-00	MICROCONTROLLER IC	M2M4	C71			CK73FB0J106K	CHIP C 10UF K	
IC3			PIC95603	ANALOGUE IC		C73 ,74			CK73GB1H102K	CHIP C 1000PF K	
IC6			S-1112B32MCG	ANALOGUE IC		C75 -77			CK73GB1C104K	CHIP C 0.10UF K	
Q1			KRC406-P	DIGITAL TRANSISTOR		C78			CK73GB1A105K	CHIP C 1.0UF K	
Q3 -5			KRC405-P	DIGITAL TRANSISTOR	KE1E2	C79 -81			CK73GB1C104K	CHIP C 0.10UF K	
Q3 -5			KRC405-P	DIGITAL TRANSISTOR	M1M2M3	C83			CC73GCH1H470J	CHIP C 47PF J	
Q3 -5			KRC405-P	DIGITAL TRANSISTOR	M4	C84			CK73GB1H153K	CHIP C 0.015UF K	
Q6 -8			KRC406-P	DIGITAL TRANSISTOR	KE1E2	C85			CK73GB1A105K	CHIP C 1.0UF K	
Q6 -8			KRC406-P	DIGITAL TRANSISTOR	M1M2M3	C86			CK73GB1H103K	CHIP C 0.010UF K	
Q6 -8			KRC406-P	DIGITAL TRANSISTOR	M4	C92			CK73FB1A225K	CHIP C 2.2UF K	
Q21 -23			KRC406-P	DIGITAL TRANSISTOR	KE1E2	C93			CC73GCH1H101J	CHIP C 100PF J	
Q21 -23			KRC406-P	DIGITAL TRANSISTOR	M1M2M3	C94			CC73GCH1H560J	CHIP C 56PF J	
Q21 -23			KRC406-P	DIGITAL TRANSISTOR	M4	C101,102			CK73GB1H103K	CHIP C 0.010UF K	
Q501,502			KRC406-P	DIGITAL TRANSISTOR	K1K2K3	C113			CK73GB1C104K	CHIP C 0.10UF K	
Q521			KRC406-P	DIGITAL TRANSISTOR	K1K2K3	CN1			E41-2954-05	FLAT CABLE CONNECTOR	
CD PLAYER UNIT (X32-6260-01) IN CD MECHA						CN2			E41-2083-15	FLAT CABLE CONNECTOR	
C1 ,2			CK73GB1A105K	CHIP C 1.0UF K		X1			L77-2964-05	CRYSTAL RESONATOR (9.00MHZ)	
C3			CK73GB1A474K	CHIP C 0.47UF K		X2			L77-2921-15	CRYSTAL RESONATOR (32.768KHZ)	
C4 -7			CK73GB1A105K	CHIP C 1.0UF K		X3			L78-1221-05	RESONATOR (16.93MHZ)	
C9			CK73GB1C104K	CHIP C 0.10UF K		CP10			RK74GA1J101J	CHIP-COM 100 J 1/16W	
C11			CK73GB1H153K	CHIP C 0.015UF K		CP11,12			RK74GB1J101J	CHIP-COM 100 J 1/16W	
C12			CK73GB1H103K	CHIP C 0.010UF K		CP15			RK74GB1J103J	CHIP-COM 10K J 1/16W	
C21			CK73GB1H103K	CHIP C 0.010UF K		CP22			RK74GB1J103J	CHIP-COM 10K J 1/16W	
C22			CC73GCH1H220J	CHIP C 22PF J		R1 ,2			RK73EB2E4R7J	CHIP R 4.7 J 1/4W	
C23			CC73GCH1H180J	CHIP C 18PF J		R3			RK73GB2A202J	CHIP R 2.0K J 1/10W	
C24 ,25			CK73GB1H103K	CHIP C 0.010UF K		R4			RK73GB2A103J	CHIP R 10K J 1/10W	
C26			CK73FB0J106K	CHIP C 10UF K		R10			RK73GB2A000J	CHIP R 0.0 J 1/10W	
C27			CK73GB1A105K	CHIP C 1.0UF K		R19			RK73GB2A223J	CHIP R 22K J 1/10W	
C28			CK73GB1H103K	CHIP C 0.010UF K		R21			RK73GB2A102J	CHIP R 1.0K J 1/10W	
C29			CK73FB0J106K	CHIP C 10UF K		R23			RK73GB2A223J	CHIP R 22K J 1/10W	
C30 -33			CK73GB1H103K	CHIP C 0.010UF K		R24			RK73GB2A101J	CHIP R 100 J 1/10W	
C34 ,35			CC73GCH1H150J	CHIP C 15PF J		R25			RK73GB2A104J	CHIP R 100K J 1/10W	
C36			CK73GB1H103K	CHIP C 0.010UF K		R26			RK73GB2A2R2J	CHIP R 2.2 J 1/10W	
C37			CK73GB1A105K	CHIP C 1.0UF K		R27			RK73GB2A101J	CHIP R 100 J 1/10W	
C38			CK73GB1H103K	CHIP C 0.010UF K		R28 ,29			RK73GB2A102J	CHIP R 1.0K J 1/10W	
C51			CK73GB1C104K	CHIP C 0.10UF K		R30			RK73GB2A223J	CHIP R 22K J 1/10W	
C52			CK73GB1H222K	CHIP C 2200PF K		R31			RK73GB2A000J	CHIP R 0.0 J 1/10W	
C53			CK73FB1C105K	CHIP C 1.0UF K		R33			RK73GB2A223J	CHIP R 22K J 1/10W	
C54			CK73GB1H103K	CHIP C 0.010UF K		R36			RK73GB2A102J	CHIP R 1.0K J 1/10W	
C55			CK73GB1H332K	CHIP C 3300PF K		R38			RK73GB2A102J	CHIP R 1.0K J 1/10W	

K: KDC-X994 K1: KDC-BT945U K2: KDC-X794 K3: KDC-MP745U M1: KDC-X8016BT
M2: KDC-X8016BTL M3: KDC-X7016 M4: KDC-X7016L E1: KDC-BT60U E1: KDC-6047U

⚠ indicates safety critical components.

PARTS LIST

CD PLAYER UNIT (X32-6260-01) IN CD MECHA

Ref.No.	A d d	N e w	Parts No.	Description	Dest inati on	Ref.No.	A d d	N e w	Parts No.	Description	Dest inati on
R41			RK73GB2A223J	CHIP R 22K J 1/10W		IC2			TC94A92FG-301	MOS-IC	
R44			RK73GB2A223J	CHIP R 22K J 1/10W		IC3			BD8222EFV	ANALOGUE IC	
R45			RK73GB2A101J	CHIP R 100 J 1/10W		IC4			MFI341S2162	MICROPROCESSOR IC	
R47			RK73GB2A000J	CHIP R 0.0 J 1/10W		IC5			74AHCT08PW	MOS-IC	
R48			RK73GB2A105J	CHIP R 1.0M J 1/10W		IC6			74LVC08APW	MOS-IC	
R49			RK73GB2A102J	CHIP R 1.0K J 1/10W		IC7			XC6415S001P1	MOS-IC	
R50			RK73GB2A223J	CHIP R 22K J 1/10W		IC9			XC6219B332MR	ANALOGUE IC	
R51			RK73GB2A102J	CHIP R 1.0K J 1/10W		Q3			RUE003N02	FET	
R52			RK73GB2A100J	CHIP R 10 J 1/10W		Q5			2SA1577	TRANSISTOR	
R53			RK73GB2A153J	CHIP R 15K J 1/10W		Q6			DTC114YUA	DIGITAL TRANSISTOR	
R54			RK73GB2A100J	CHIP R 10 J 1/10W		Q7			2SA1365-T1(E)	TRANSISTOR	
R55			RK73GB2A153J	CHIP R 15K J 1/10W		Q9			DTC144EUA	DIGITAL TRANSISTOR	
R57			RK73GB2A223J	CHIP R 22K J 1/10W		ELECTRIC UNIT (X34-664x-xx)					
R58 ,59			RK73GB2A101J	CHIP R 100 J 1/10W		C2			CD04AZ1C332M2	ELECTRO 3300UF 16WV	E2M1M
R63			RK73GB2A223J	CHIP R 22K J 1/10W		C2			CD04AZ1C332M2	ELECTRO 3300UF 16WV	K1K3E
R65 ,66			RK73GB2A332J	CHIP R 3.3K J 1/10W		C2			CD04AZ1C332M2	ELECTRO 3300UF 16WV	M3M4
R67 -69			RK73GB2A101J	CHIP R 100 J 1/10W		C2			C90-6784-05	ELECTRO 3900UF 16WV	KK2
R70			RK73GB2A223J	CHIP R 22K J 1/10W		C10			CD04AR1C221M	ELECTRO 220UF 16WV	
R81 ,82			RK73GB2A101J	CHIP R 100 J 1/10W		C12			CK73GB1A105K	CHIP C 1.0UF K	
R84			RK73GB2A101J	CHIP R 100 J 1/10W		C20 ,21			CK73GB1A105K	CHIP C 1.0UF K	
R86			RK73GB2A101J	CHIP R 100 J 1/10W		C30			CD04AS1C101M	ELECTRO 100UF 16WV	
R88			RK73GB2A101J	CHIP R 100 J 1/10W		C31			CK73FB0J106K	CHIP C 10UF K	
R90 -94			RK73GB2A101J	CHIP R 100 J 1/10W		C33			C90-6851-05	ELECTRO 220UF 25WV	
R95 -98			RK73GB2A223J	CHIP R 22K J 1/10W		C40			CD04AS1C220M	ELECTRO 22UF 16WV	KK2
R101			RK73GB2A221J	CHIP R 220 J 1/10W		C41			CK73GB1C104K	CHIP C 0.10UF K	
R102			RK73GB2A4R7J	CHIP R 4.7 J 1/10W		C50			CD04AS1C220M	ELECTRO 22UF 16WV	
R103			RK73GB2A102J	CHIP R 1.0K J 1/10W		C52			CK73GB1C473K	CHIP C 0.047UF K	
R104			RK73GB2A225J	CHIP R 2.2M J 1/10W		C71			CK73FB0J106K	CHIP C 10UF K	
R105			RK73GB2A104J	CHIP R 100K J 1/10W		C72			CK73GB1A474K	CHIP C 0.47UF K	
R106			RK73GB2A472J	CHIP R 4.7K J 1/10W		C73			CK73EB1H475K	CHIP C 4.7UF K	
R107			RK73GB2A560J	CHIP R 56 J 1/10W		C74			CK73GB1H102K	CHIP C 1000PF K	
R108			RK73GB2A333J	CHIP R 33K J 1/10W		C75			CK73GB1C104K	CHIP C 0.10UF K	
R109			RK73GB2A622J	CHIP R 6.2K J 1/10W		C79			CK73GB1H102K	CHIP C 1000PF K	
R110			RK73GB2A913J	CHIP R 91K J 1/10W		C81 ,82			CK73GB1H102K	CHIP C 1000PF K	E1E2M
R112,113			RK73GB2A4R7J	CHIP R 4.7 J 1/10W		C81 ,82			CK73GB1H102K	CHIP C 1000PF K	KK1K2
R115			RK73GB2A105J	CHIP R 1.0M J 1/10W		C81 ,82			CK73GB1H102K	CHIP C 1000PF K	M2M3M
R116			RK73GB2A681J	CHIP R 680 J 1/10W		C83			CD04AS1V100M	ELECTRO 10UF 35WV	E1E2M
R117-121			RK73GB2A103J	CHIP R 10K J 1/10W		C83			CD04AS1V100M	ELECTRO 10UF 35WV	KK1K2
R123			RK73GB2A104J	CHIP R 100K J 1/10W		C83			CD04AS1V100M	ELECTRO 10UF 35WV	M2M3M
R127			RK73GB2A153J	CHIP R 15K J 1/10W		C84			CD04AS1C220M	ELECTRO 22UF 16WV	E1E2M
R128			RK73GB2A334J	CHIP R 330K J 1/10W		C84			CD04AS1C220M	ELECTRO 22UF 16WV	KK1K2
R131			RK73GB2A204J	CHIP R 200K J 1/10W		C84			CD04AS1C220M	ELECTRO 22UF 16WV	M2M3M
R132			RK73GB2A101J	CHIP R 100 J 1/10W		C92			CK73GB1H103K	CHIP C 0.010UF K	
R136			RK73GB2A363J	CHIP R 36K J 1/10W		C110			CK73GB1H104K	CHIP C 0.10UF K	
R137			RK73GB2A223J	CHIP R 22K J 1/10W		C111			CK73GB1A105K	CHIP C 1.0UF K	
R139			RK73GB2A393J	CHIP R 39K J 1/10W		C112			CK73FB1A335K	CHIP C 3.3UF K	
R151			RK73GB2A333J	CHIP R 33K J 1/10W		C131			CK73GB1A105K	CHIP C 1.0UF K	
R152			RK73GB2A223J	CHIP R 22K J 1/10W		C132			CK73GB1H223K	CHIP C 0.022UF K	
R173-178			RK73GB2A2R2J	CHIP R 2.2 J 1/10W		C133			CK73GB1H103K	CHIP C 0.010UF K	
R180			RK73GB2A102J	CHIP R 1.0K J 1/10W		C151			CK73GB1C104K	CHIP C 0.10UF K	
S1 ,2			S68-0924-05	PUSH SWITCH		C153			CK73GB1C104K	CHIP C 0.10UF K	
D1			DAP202U	DIODE		C154			CD04BF1C221M	ELECTRO 220UF 16WV	
D2 ,3			DA204U	DIODE		C170,171			CK73GB1H103K	CHIP C 0.010UF K	KK1E1
IC1			92CD28AFG7EG0	MICROCONTROLLER IC		C170,171			CK73GB1H103K	CHIP C 0.010UF K	M1M2

K: KDC-X994 K1: KDC-BT945U K2: KDC-X794 K3: KDC-MP745U M1: KDC-X8016BT
M2: KDC-X8016BTL M3: KDC-X7016 M4: KDC-X7016L E1: KDC-BT60U E1: KDC-6047U

⚠ indicates safety critical components.

PARTS LIST

ELECTRIC UNIT (X34-664x-xx)

Ref.No.	A d d	N e w	Parts No.	Description	Dest inati on	Ref.No.	A d d	N e w	Parts No.	Description	Dest inati on
C204			CK73GB1A105K	CHIP C 1.0UF K		C532-535			C90-6768-05	ELECTRO 0.22UF 16WV	KK2
C206			CD04BA1E330M	ELECTRO 33UF 25WV		C604			CK73GB1C104K	CHIP C 0.10UF K	KK1E1
C210-213			CK73GB1C224K	CHIP C 0.22UF K	E2M1M2	C604			CK73GB1C104K	CHIP C 0.10UF K	M1M2
C210-213			CK73GB1C224K	CHIP C 0.22UF K	K1K3E1	C606			CD04AS0J101M	ELECTRO 100UF 6.3WV	KK1E1
C210-213			CK73GB1C224K	CHIP C 0.22UF K	M3M4	C606			CD04AS0J101M	ELECTRO 100UF 6.3WV	M1M2
C217			CK73FB1C105K	CHIP C 1.0UF K	E2M1M2	C607,608			CC73GCH1H470J	CHIP C 47PF J	KK1E1
C217			CK73FB1C105K	CHIP C 1.0UF K	K1K3E1	C607,608			CC73GCH1H470J	CHIP C 47PF J	M1M2
C217			CK73FB1C105K	CHIP C 1.0UF K	M3M4	C610,611			CK73GB1A105K	CHIP C 1.0UF K	KK1E1
C222			CK73GB1A105K	CHIP C 1.0UF K		C610,611			CK73GB1A105K	CHIP C 1.0UF K	M1M2
C230			C90-6765-05	ELECTRO 1UF 16WV	KK2	C612			CK73GB1C104K	CHIP C 0.10UF K	KK1E1
C240,241			CK73GB1A105K	CHIP C 1.0UF K		C612			CK73GB1C104K	CHIP C 0.10UF K	M1M2
C242-247			CK73GB1H103K	CHIP C 0.010UF K		C614			CK73GB0J225K	CHIP C 2.2UF K	KK1E1
C250			CD04AS1V100M	ELECTRO 10UF 35WV		C614			CK73GB0J225K	CHIP C 2.2UF K	M1M2
C251			CD04AS0J470M	ELECTRO 47UF 6.3WV		C615			CK73GB1A105K	CHIP C 1.0UF K	KK1E1
C252			CK73GB0J225K	CHIP C 2.2UF K		C615			CK73GB1A105K	CHIP C 1.0UF K	M1M2
C253-256			CK73GB1H103K	CHIP C 0.010UF K		C618,619			CK73GB1A105K	CHIP C 1.0UF K	KK1E1
C257			CC73GCH1H120J	CHIP C 12PF J		C618,619			CK73GB1A105K	CHIP C 1.0UF K	M1M2
C259			CC73GCH1H120J	CHIP C 12PF J		C623,624			CC73GCH1H470J	CHIP C 47PF J	KK1E1
C260			CK73GB1A105K	CHIP C 1.0UF K		C623,624			CC73GCH1H470J	CHIP C 47PF J	M1M2
C261			CK73GB1A474K	CHIP C 0.47UF K		C627,628			CK73GB1H102K	CHIP C 1000PF K	KK1E1
C262			CK73GB1A105K	CHIP C 1.0UF K		C627,628			CK73GB1H102K	CHIP C 1000PF K	M1M2
C263			CK73GB1A474K	CHIP C 0.47UF K		C640			CC73GCH1H221J	CHIP C 220PF J	KK1E1
C264-266			CK73GB1A105K	CHIP C 1.0UF K		C640			CC73GCH1H221J	CHIP C 220PF J	M1M2
C269,270			CD04AS1H2R2M	ELECTRO 2.2UF 50WV	KK2	CN161			E41-1701-05	PIN ASSY	
C271,272			CK73GB1A105K	CHIP C 1.0UF K		CN170			E41-1822-05	FLAT CABLE CONNECTOR	
C276			CD04AS1H2R2M	ELECTRO 2.2UF 50WV		CN520			E40-9747-05	PIN ASSY	
C277			CK73GB1H103K	CHIP C 0.010UF K		CN600		*	E41-3140-05	PIN ASSY	KK1E1
C280-285			CK73GB1A105K	CHIP C 1.0UF K		CN600		*	E41-3140-05	PIN ASSY	M1M2
C286			CD04AS1C470M	ELECTRO 47UF 16WV		CN600					
C288,289			CK73GB1A105K	CHIP C 1.0UF K	E2M1M2	CN603			E41-1699-05	PIN ASSY	KK1E1
C288,289			CK73GB1A105K	CHIP C 1.0UF K	K1K3E1	CN603			E41-1699-05	PIN ASSY	M1M2
C300			CK73GB1C104K	CHIP C 0.10UF K	M3M4	J1			E58-0991-05	RECTANGULAR RECEPTACLE	
C301			CK73GB1H103K	CHIP C 0.010UF K		J400			E56-0855-05	CYLINDRICAL RECEPTACLE	
C302,303			CC73GCH1H220J	CHIP C 22PF J		J420			E63-0972-05	PIN JACK	
C305,306			CK73GB1H103K	CHIP C 0.010UF K		J470			E11-0625-05	PHONE JACK	
C307			CK73GB1H102K	CHIP C 1000PF K		W481	2D		E30-6803-05	CORD WITH PLUG	
C310-312			CK73GB1H103K	CHIP C 0.010UF K		L1			L33-2365-05	CHOKE COIL ASSY	
C314,315			CK73GB1H103K	CHIP C 0.010UF K		L70			L33-2462-05	SMALL FIXED INDUCTOR (22UH)	
C316			CK73GB1C104K	CHIP C 0.10UF K		L71			L92-0639-05	CHIP FERRITE	
C400,401			CK73GB1A105K	CHIP C 1.0UF K		X240			L77-3810-05	CRYSTAL RESONATOR (11.2896MHZ)	
C402			CD04AS0J470M	ELECTRO 47UF 6.3WV		X300			L78-0872-05	RESONATOR (12MHZ)	
C440,441			CD04AS1V100M	ELECTRO 10UF 35WV		X301			L77-2921-15	CRYSTAL RESONATOR (32.768KHZ)	
C450,451			CD04AS1V100M	ELECTRO 10UF 35WV		X500			L77-3825-05	CRYSTAL RESONATOR (4.332MHZ)	E2
C460,461			CD04AS1V100M	ELECTRO 10UF 35WV		X500			L77-3825-05	CRYSTAL RESONATOR (4.332MHZ)	KK2E1
C470,471			CK73GB1A105K	CHIP C 1.0UF K		K	2D		N80-3008-48	PAN HEAD TAPTITE SCREW	
C472			CD04AS0J470M	ELECTRO 47UF 6.3WV		L	2D		N83-3005-48	PAN HEAD TAPTITE SCREW	
C482-485			CK73GB1H103K	CHIP C 0.010UF K		M	2D		N83-3008-48	PAN HEAD TAPTITE SCREW	
C502			CK73GB0J225K	CHIP C 2.2UF K	E2	N	2D		N83-3016-48	PAN HEAD TAPTITE SCREW	
C502			CK73GB0J225K	CHIP C 2.2UF K	KK2E1	P	3D		N86-2604-43	BINDING HEAD TAPTITE SCREW	
C503			CC73GCH1H271J	CHIP C 270PF J	E2	CP301-303			RK74HB1J101J	CHIP-COM 100 J 1/16W	
C503			CC73GCH1H271J	CHIP C 270PF J	KK2E1	CP304			RK74GA1J101J	CHIP-COM 100 J 1/16W	KK1E1
C505			CK73GB1H103K	CHIP C 0.010UF K		CP304			RK74GA1J101J	CHIP-COM 100 J 1/16W	M1M2
C506,507			CC73GCH1H120J	CHIP C 12PF J	E2	CP306			RK74GA1J472J	CHIP-COM 4.7K J 1/16W	
C506,507			CC73GCH1H120J	CHIP C 12PF J	KK2E1	CP307			RK74HB1J101J	CHIP-COM 100 J 1/16W	

K: KDC-X994 K1: KDC-BT945U K2: KDC-X794 K3: KDC-MP745U M1: KDC-X8016BT
M2: KDC-X8016BTL M3: KDC-X7016 M4: KDC-X7016L E1: KDC-BT60U E1: KDC-6047U

⚠ indicates safety critical components.

PARTS LIST

ELECTRIC UNIT (X34-664x-xx)

Ref.No.	A d d	N e w	Parts No.	Description	Dest inati on	Ref.No.	A d d	N e w	Parts No.	Description	Dest inati on
CP501			RK74HB1J222J	CHIP-COM 2.2K J 1/16W	E2	R201			RK73GB2A333J	CHIP R 33K J 1/10W	
CP501			RK74HB1J222J	CHIP-COM 2.2K J 1/16W	KK2E1	R202			RK73GB2A000J	CHIP R 0.0 J 1/10W	
R1 ,2			RK73EB2E103J	CHIP R 10K J 1/4W		R208	*		RK73GB2A100JH	CHIP R 10 J 1/10W	
R10			RK73GH2A243D	CHIP R 24K D 1/10W		R209			RK73GB2A432J	CHIP R 4.3K J 1/10W	
R11			RK73GH2A432D	CHIP R 4.3K D 1/10W		R210			RK73GB2A221J	CHIP R 220 J 1/10W	
R12			RK73FB2B221J	CHIP R 220 J 1/8W		R212,213			RK73GB2A223J	CHIP R 22K J 1/10W	
R22			RK73GB2A1R0J	CHIP R 1.0 J 1/10W		R240			RK73EB2E2R2J	CHIP R 2.2 J 1/4W	
R33			RK73FB2B123J	CHIP R 12K J 1/8W		R242-247	*		RK73GB2A101JH	CHIP R 100 J 1/10W	
R41			RK73FB2B152J	CHIP R 1.5K J 1/8W		R248			RK73GB2A152J	CHIP R 1.5K J 1/10W	
R52			RK73FB2B272J	CHIP R 2.7K J 1/8W		R249			RK73EB2E2R2J	CHIP R 2.2 J 1/4W	
R71			RK73GH2A133D	CHIP R 13K D 1/10W		R260			RK73GB2A103J	CHIP R 10K J 1/10W	
R72			RK73GH2A823D	CHIP R 82K D 1/10W		R268			RK73GB2A000J	CHIP R 0.0 J 1/10W	K3
R73			RK73GB2A103J	CHIP R 10K J 1/10W		R300			RK73GB2A473J	CHIP R 47K J 1/10W	
R74			RK73GH2A153D	CHIP R 15K D 1/10W		R302			RK73GB2A103J	CHIP R 10K J 1/10W	
R83			RK73GB2A362J	CHIP R 3.6K J 1/10W	E1E2M1	R303,304			RK73GB2A104J	CHIP R 100K J 1/10W	
R83			RK73GB2A362J	CHIP R 3.6K J 1/10W	KK1K2	R306			RK73GB2A104J	CHIP R 100K J 1/10W	
R83			RK73GB2A362J	CHIP R 3.6K J 1/10W	M2M3M4	R308			RK73GB2A101J	CHIP R 100 J 1/10W	
R84			RK73GB2A432J	CHIP R 4.3K J 1/10W	E1E2M1	R309			RK73GB2A473J	CHIP R 47K J 1/10W	
R84			RK73GB2A432J	CHIP R 4.3K J 1/10W	KK1K2	R312			RK73GB2A101J	CHIP R 100 J 1/10W	
R84			RK73GB2A432J	CHIP R 4.3K J 1/10W	M2M3M4	R313			RK73GB2A102J	CHIP R 1.0K J 1/10W	
R85			RK73GB2A562J	CHIP R 5.6K J 1/10W	E1E2M1	R314			RK73GB2A223J	CHIP R 22K J 1/10W	E1E2
R85			RK73GB2A562J	CHIP R 5.6K J 1/10W	KK1K2	R315			RK73GB2A222J	CHIP R 2.2K J 1/10W	
R85			RK73GB2A562J	CHIP R 5.6K J 1/10W	M2M3M4	R316			RK73GB2A473J	CHIP R 47K J 1/10W	
R86			RK73GB2A2R2J	CHIP R 2.2 J 1/10W	E1E2M1	R317			RK73GB2A102J	CHIP R 1.0K J 1/10W	
R86			RK73GB2A2R2J	CHIP R 2.2 J 1/10W	KK1K2	R318			RK73GB2A473J	CHIP R 47K J 1/10W	
R86			RK73GB2A2R2J	CHIP R 2.2 J 1/10W	M2M3M4	R319			RK73GB2A104J	CHIP R 100K J 1/10W	
R87			RK73FB2B102J	CHIP R 1.0K J 1/8W	E1E2M1	R320			RK73GB2A333J	CHIP R 33K J 1/10W	
R87			RK73FB2B102J	CHIP R 1.0K J 1/8W	KK1K2	R321			RK73GB2A473J	CHIP R 47K J 1/10W	
R87			RK73FB2B102J	CHIP R 1.0K J 1/8W	M2M3M4	R322			RK73GB2A102J	CHIP R 1.0K J 1/10W	
R90 ,91			RK73GB2A103J	CHIP R 10K J 1/10W		R323			RK73GB2A473J	CHIP R 47K J 1/10W	
R96			RK73GB2A183J	CHIP R 18K J 1/10W		R324			RK73GB2A472J	CHIP R 4.7K J 1/10W	
R97			RK73GB2A104J	CHIP R 100K J 1/10W		R325			RK73GB2A104J	CHIP R 100K J 1/10W	
R98			RK73FB2B203J	CHIP R 20K J 1/8W		R326			RK73GB2A472J	CHIP R 4.7K J 1/10W	
R99			RK73EB2E473J	CHIP R 47K J 1/4W		R327,328			RK73GB2A104J	CHIP R 100K J 1/10W	
R100			RK73FB2B683J	CHIP R 68K J 1/8W		R329			RK73GB2A473J	CHIP R 47K J 1/10W	
R101			RK73GB2A473J	CHIP R 47K J 1/10W		R330			RK73GB2A104J	CHIP R 100K J 1/10W	
R102-104			RK73EB2E102J	CHIP R 1.0K J 1/4W		R331			RK73GB2A222J	CHIP R 2.2K J 1/10W	KK1K2
R110,111			RK73PB2H561J	CHIP R 560 J 1/2W		R331			RK73GB2A222J	CHIP R 2.2K J 1/10W	K3M1M
R112			RK73GB2A223J	CHIP R 22K J 1/10W		R331			RK73GB2A222J	CHIP R 2.2K J 1/10W	M3M4
R113,114			RK73PB2H561J	CHIP R 560 J 1/2W		R331,332			RK73GB2A222J	CHIP R 2.2K J 1/10W	E1E2
R115			RK73FB2B472J	CHIP R 4.7K J 1/8W		R333			RK73GB2A104J	CHIP R 100K J 1/10W	
R116			RK73GB2A223J	CHIP R 22K J 1/10W	KK1K2	R335,336			RK73GB2A104J	CHIP R 100K J 1/10W	
R116			RK73GB2A223J	CHIP R 22K J 1/10W	K3M1M2	R337-340			RK73GB2A473J	CHIP R 47K J 1/10W	
R116			RK73GB2A223J	CHIP R 22K J 1/10W	M3M4	R341,342			RK73GB2A102J	CHIP R 1.0K J 1/10W	
R117			RK73GB2A000J	CHIP R 0.0 J 1/10W	E1E2	R344			RK73GB2A102J	CHIP R 1.0K J 1/10W	
R118,119			RK73PB2H221J	CHIP R 220 J 1/2W	KK1K2	R345			RK73GB2A000J	CHIP R 0.0 J 1/10W	
R118,119			RK73PB2H221J	CHIP R 220 J 1/2W	K3M1M2	R348			RK73GB2A471J	CHIP R 470 J 1/10W	
R118,119			RK73PB2H221J	CHIP R 220 J 1/2W	M3M4	R350,351			RK73GB2A471J	CHIP R 470 J 1/10W	
R120			RK73FB2B472J	CHIP R 4.7K J 1/8W		R352			RK73GB2A223J	CHIP R 22K J 1/10W	E1E2
R130,131			RK73GB2A104J	CHIP R 100K J 1/10W		R352			RK73GB2A473J	CHIP R 47K J 1/10W	M1M2M
R132			RK73GB2A473J	CHIP R 47K J 1/10W		R352			RK73GB2A473J	CHIP R 47K J 1/10W	M4
R150			RK73GB2A223J	CHIP R 22K J 1/10W		R353			RK73GB2A223J	CHIP R 22K J 1/10W	KK2M1
R151			RK73GB2A101J	CHIP R 100 J 1/10W		R353			RK73GB2A223J	CHIP R 22K J 1/10W	M3
R160			RK73EB2E471J	CHIP R 470 J 1/4W		R353,354			RK73GB2A223J	CHIP R 22K J 1/10W	K1K3M
R164,165			RK73GB2A150J	CHIP R 15 J 1/10W		R353,354			RK73GB2A223J	CHIP R 22K J 1/10W	M4

K: KDC-X994 K1: KDC-BT945U K2: KDC-X794 K3: KDC-MP745U M1: KDC-X8016BT

M2: KDC-X8016BTL M3: KDC-X7016 M4: KDC-X7016L E1: KDC-BT60U E1: KDC-6047U

▲ indicates safety critical components.

PARTS LIST

ELECTRIC UNIT (X34-664x-xx)

Ref.No.	A d d	N e w	Parts No.	Description	Dest inati on	Ref.No.	A d d	N e w	Parts No.	Description	Dest inati on
R355			RK73GB2A223J	CHIP R 22K J 1/10W	E2M1M3	R647			RK73GB2A473J	CHIP R 47K J 1/10W	M1M2
R355			RK73GB2A223J	CHIP R 22K J 1/10W	KK2E1	R649			RK73GB2A223J	CHIP R 22K J 1/10W	KK1E1
R357			RK73GB2A222J	CHIP R 2.2K J 1/10W		R649			RK73GB2A223J	CHIP R 22K J 1/10W	M1M2
R360			RK73GB2A223J	CHIP R 22K J 1/10W		R650			RK73GB2A473J	CHIP R 47K J 1/10W	KK1E1
R361			RK73GB2A104J	CHIP R 100K J 1/10W		R650			RK73GB2A473J	CHIP R 47K J 1/10W	M1M2
R400-404			RK73EB2E432J	CHIP R 4.3K J 1/4W		W13			R92-2053-05	CHIP R 0 OHM J 1/8W	
R405			RK73EB2E101J	CHIP R 100 J 1/4W		W80			R92-2053-05	CHIP R 0 OHM J 1/8W	K3
R406,407			RK73EB2E100J	CHIP R 10 J 1/4W		W480			R92-2053-05	CHIP R 0 OHM J 1/8W	
R408			RK73EB2E4R7J	CHIP R 4.7 J 1/4W		S520			S74-0809-05	MICRO SWITCH	
R409			RK73EB2E432J	CHIP R 4.3K J 1/4W		D1			S2V60-5009F46	DIODE	
R410			RK73EB2E101J	CHIP R 100 J 1/4W		D30			UDZW5.6(B)	ZENER DIODE	
R411			RK73GB2A102J	CHIP R 1.0K J 1/10W		D31			D1FJ4	DIODE	
R440,441			RK73GB2A331J	CHIP R 330 J 1/10W		D40			UDZW8.2(B)	ZENER DIODE	
R442,443			RK73GB2A223J	CHIP R 22K J 1/10W		D50			UDZW11(B)	ZENER DIODE	K1K2K
R444,445			RK73FB2B181J	CHIP R 180 J 1/8W		D51			1SS355	DIODE	KE1E2
R450,451			RK73GB2A331J	CHIP R 330 J 1/10W		D51			1SS355	DIODE	M1M2
R452,453			RK73GB2A223J	CHIP R 22K J 1/10W		D51			1SS355	DIODE	M4
R454,455			RK73FB2B181J	CHIP R 180 J 1/8W		D52			UDZW10(B)	ZENER DIODE	KE1E2
R460,461			RK73GB2A331J	CHIP R 330 J 1/10W		D52			UDZW10(B)	ZENER DIODE	M1M2
R462,463			RK73GB2A223J	CHIP R 22K J 1/10W		D52			UDZW10(B)	ZENER DIODE	M4
R464,465			RK73FB2B181J	CHIP R 180 J 1/8W		D70			CMS14	DIODE	
R470,471			RK73EB2E101J	CHIP R 100 J 1/4W		D80			1SR154-400	DIODE	E1E2M
R472,473			RK73GB2A123J	CHIP R 12K J 1/10W		D80			1SR154-400	DIODE	KK1K2
R474			RK73EB2E470J	CHIP R 47 J 1/4W		D80			1SR154-400	DIODE	M2M3
R475			RK73GB2A102J	CHIP R 1.0K J 1/10W		D82			UDZW5.6(B)	ZENER DIODE	E1E2M
R480,481			RK73GB2A471J	CHIP R 470 J 1/10W		D82			UDZW5.6(B)	ZENER DIODE	KK1K2
R482			RK73FB2B821J	CHIP R 820 J 1/8W		D82			UDZW5.6(B)	ZENER DIODE	M2M3
R483			RK73GB2A223J	CHIP R 22K J 1/10W		D90			UDZW6.2(B)	ZENER DIODE	
R505			RK73GB2A102J	CHIP R 1.0K J 1/10W	E2	D92 ,93			UDZW6.8(B)	ZENER DIODE	
R505			RK73GB2A102J	CHIP R 1.0K J 1/10W	KK2E1	D110			1SS355	DIODE	
R532			RK73GB2A473J	CHIP R 47K J 1/10W		D111-114			1SR154-400	DIODE	
R533			RK73GB2A102J	CHIP R 1.0K J 1/10W		D130			UDZW4.7(B)	ZENER DIODE	
R534			RK73GB2A472J	CHIP R 4.7K J 1/10W		D164,165			LVS10C270S030	VARISTOR	
R535			RK73GB2A223J	CHIP R 22K J 1/10W		D200			DAP202U	DIODE	
R603			RK73GB2A2R2J	CHIP R 2.2 J 1/10W	KK1E1	D201			1SS355	DIODE	
R603			RK73GB2A2R2J	CHIP R 2.2 J 1/10W	M1M2	D263-265			DAP202U	DIODE	
R606,607			RK73GB2A222J	CHIP R 2.2K J 1/10W	KK1E1	D403			UDZW6.2(B)	ZENER DIODE	
R606,607			RK73GB2A222J	CHIP R 2.2K J 1/10W	M1M2	D406			UDZW6.2(B)	ZENER DIODE	
R610-613			RK73GB2A223J	CHIP R 22K J 1/10W	KK1E1	D408,409			UDZW6.8(B)	ZENER DIODE	
R610-613			RK73GB2A223J	CHIP R 22K J 1/10W	M1M2	D410			UDZW6.2(B)	ZENER DIODE	
R614			RK73GB2A473J	CHIP R 47K J 1/10W	KK1E1	D441			DAP202U	DIODE	
R614			RK73GB2A473J	CHIP R 47K J 1/10W	M1M2	D461			DAP202U	DIODE	
R617			RK73GB2A473J	CHIP R 47K J 1/10W	KK1E1	D470,471			UDZW6.8(B)	ZENER DIODE	
R617			RK73GB2A473J	CHIP R 47K J 1/10W	M1M2	D472			UDZW6.2(B)	ZENER DIODE	
R620			RK73GB2A472J	CHIP R 4.7K J 1/10W	KK1E1	D531			UDZW12(B)	ZENER DIODE	E1E2
R620			RK73GB2A472J	CHIP R 4.7K J 1/10W	M1M2	D532			DA204U	DIODE	
R624-627			RK73GB2A223J	CHIP R 22K J 1/10W	KK1E1	D536			UDZW6.2(B)	ZENER DIODE	E1E2
R624-627			RK73GB2A223J	CHIP R 22K J 1/10W	M1M2	D602.603			UDZW4.7(B)	ZENER DIODE	KK1E1
R633,634			RK73GB2A331J	CHIP R 330 J 1/10W	KK1E1	D602.603			UDZW4.7(B)	ZENER DIODE	M1M2
R633,634			RK73GB2A331J	CHIP R 330 J 1/10W	M1M2	IC10			M5237ML-CF0J	ANALOGUE IC	
R638,639			RK73EB2E101J	CHIP R 100 J 1/4W	KK1E1	IC20			XC6201P502PR	ANALOGUE IC	
R638,639			RK73EB2E101J	CHIP R 100 J 1/4W	M1M2	IC70		3D *	Impossible to repla	ANALOGUE IC (See exploded view)	
R645			RK73GB2A681J	CHIP R 680 J 1/10W	KK1E1	IC150			BD6538G	MOS-IC	
R645			RK73GB2A681J	CHIP R 680 J 1/10W	M1M2	IC170			74AHCT1G08GW	MOS-IC	KK1E1
R647			RK73GB2A473J	CHIP R 47K J 1/10W	KK1E1						

K: KDC-X994 **K1:** KDC-BT945U **K2:** KDC-X794 **K3:** KDC-MP745U **M1:** KDC-X8016BT
M2: KDC-X8016BTL **M3:** KDC-X7016 **M4:** KDC-X7016L **E1:** KDC-BT60U **E1:** KDC-6047U

 indicates safety critical components.

PARTS LIST

ELECTRIC UNIT (X34-664x-xx)

Ref.No.	A d d	N e w	Parts No.	Description	Dest inati on	Ref.No.	A d d	N e w	Parts No.	Description	Dest inati on
IC170			74AHCT1G08GW	MOS-IC	M1M2	Q115			KRC407-P	DIGITAL TRANSISTOR	K3M1M
IC171			74AHC1G08GW	MOS-IC	KK1E1	Q115			KRC407-P	DIGITAL TRANSISTOR	M3M4
IC171			74AHC1G08GW	MOS-IC	M1M2	Q130			KRC404-P	DIGITAL TRANSISTOR	
IC201			E-TDA7850A	ANALOGUE IC		Q170			KRC403-P	DIGITAL TRANSISTOR	KK1E1
IC240			AK7600VF	MOS-IC		Q170			KRC403-P	DIGITAL TRANSISTOR	M1M2
IC301			XC6120N362N-G	MOS-IC		Q440,441			KRC410-P	DIGITAL TRANSISTOR	
IC302		*	W05-1595-00	MICROCONTROLLER IC	KK1M1	Q442			KRA303-P	DIGITAL TRANSISTOR	
IC302		*	W05-1595-00	MICROCONTROLLER IC	M2	Q450,451			KRC410-P	DIGITAL TRANSISTOR	
IC302		*	W05-1596-00	MICROCONTROLLER IC	K2K3M3	Q460,461			KRC410-P	DIGITAL TRANSISTOR	
IC302		*	W05-1596-00	MICROCONTROLLER IC	M4	Q462			KRA303-P	DIGITAL TRANSISTOR	
IC302		*	W05-1597-00	MICROCONTROLLER IC	E1	Q480			KRC403-P	DIGITAL TRANSISTOR	
IC302		*	W05-1598-00	MICROCONTROLLER IC	E2	Q481			2SA1577	TRANSISTOR	
IC303			74HC2G02DP	MOS-IC		Q520			KRC403-P	DIGITAL TRANSISTOR	
IC451		*	E-TDA7716N	ANALOGUE IC		Q521			2SA1576A	TRANSISTOR	
IC500			E-TDA7478AD	ANALOGUE IC	E2	Q522			KRA307-P	DIGITAL TRANSISTOR	
IC500			E-TDA7478AD	ANALOGUE IC	KK2E1	TH200			PRF18BE471QS2	POSITIVE RESISTOR	
IC600			NJM4565V-ZB	ANALOGUE IC	KK1E1						
IC600			NJM4565V-ZB	ANALOGUE IC	M1M2	A600	3D		W02-5372-05	ELECTRIC CIRCUIT MODULE	KK1E1
IC603			NJM2845DL133B	ANALOGUE IC	KK1E1	A600	3D		W02-5372-05	ELECTRIC CIRCUIT MODULE	M1M2
IC603			NJM2845DL133B	ANALOGUE IC	M1M2						
Q10			KRA303-P	DIGITAL TRANSISTOR		A480	2D		X86-4032-70	FRONT-END UNIT	E1E2
Q11			KRC403-P	DIGITAL TRANSISTOR		A480	2D		X86-4230-11	FRONT-END UNIT	KK1K2
Q12			KTA1046-P	TRANSISTOR		A480	2D		X86-4230-11	FRONT-END UNIT	K3M1M
Q32			2SC4081	TRANSISTOR		A480	2D		X86-4230-11	FRONT-END UNIT	M3M4
Q33			KTA1046-P	TRANSISTOR		MECHANISM ASSY (X92-6360-04) DXM-9B30W					
Q40			2SC4081	TRANSISTOR		1	2B		A10-5450-63	CHASSIS ASSY	
Q41			KTA1046-P	TRANSISTOR		3	3B		A10-5452-41	CHASSIS	
Q42			KRA303-P	DIGITAL TRANSISTOR		4	1B		A10-5453-32	CHASSIS	
Q43			KRC403-P	DIGITAL TRANSISTOR		12	3A		D10-4993-52	LEVER	
Q50			2SC4081	TRANSISTOR		13	1B		D10-4991-22	ARM	
Q51		*	2SA1241-Q(Y)	TRANSISTOR		14	1B		D10-4992-13	ARM	
Q52			KRA303-P	DIGITAL TRANSISTOR		15	2A		D10-4994-02	SLIDER	
Q53			KRC403-P	DIGITAL TRANSISTOR		16	2A		D10-4995-03	SLIDER	
Q80			2SC4081	TRANSISTOR	E1E2M1	17	2B		D10-4996-02	SLIDER	
Q80			2SC4081	TRANSISTOR	KK1K2	18	2A		D10-4997-03	LEVER	
Q80			2SC4081	TRANSISTOR		19	1A		D10-4998-03	ARM	
Q81			2SC5053	TRANSISTOR	M2M3M4	20	2A		D10-4999-03	ARM	
Q81			2SC5053	TRANSISTOR	E1E2M1	21	2A		D10-7001-03	ARM	
Q81			2SC5053	TRANSISTOR	KK1K2	22	2A		D10-7002-03	ARM	
Q82			KRA303-P	DIGITAL TRANSISTOR	M2M3M4	23	2A		D10-7003-03	ARM	
Q82			KRA303-P	DIGITAL TRANSISTOR	E1E2M1	24	2A		D13-2445-04	GEAR	
Q82			KRA303-P	DIGITAL TRANSISTOR	KK1K2	25	2A		D13-2446-04	GEAR	
Q83			KRC403-P	DIGITAL TRANSISTOR	M2M3M4	27	2A		D13-2448-04	GEAR	
Q83			KRC403-P	DIGITAL TRANSISTOR	E1E2M1	28	2A		D13-2449-04	GEAR	
Q83			KRC403-P	DIGITAL TRANSISTOR	KK1K2	29	2A		D13-2450-04	GEAR	
Q83			KRC403-P	DIGITAL TRANSISTOR	M2M3M4	30	2A		D13-2451-04	GEAR	
Q90			2SC4081	TRANSISTOR		31	2A		D13-2452-04	GEAR	
Q92 ,93			2SC4081	TRANSISTOR		32	2A		D13-2453-04	GEAR	
Q110			KRC407-P	DIGITAL TRANSISTOR		33	2A		D13-2454-04	GEAR	
Q111			KRA302-P	DIGITAL TRANSISTOR		34	2A		D13-2455-04	GEAR	
Q112			2SA1576A	TRANSISTOR		35	2B		D13-2456-03	RACK (GEAR)	
Q113			2SB1188(Q,R)	TRANSISTOR	E1E2	36	2A		D14-1028-04	ROLLER	
Q113,114			2SB1188(Q,R)	TRANSISTOR	KK1K2	37	3A		D21-2507-04	SHAFT	
Q113,114			2SB1188(Q,R)	TRANSISTOR	K3M1M2	38	2B		D21-2508-04	SHAFT	
Q113,114			2SB1188(Q,R)	TRANSISTOR	M3M4	39	3A		D23-0963-04	RETAINER	
Q115			KRC407-P	DIGITAL TRANSISTOR	KK1K2						

K: KDC-X994 K1: KDC-BT945U K2: KDC-X794 K3: KDC-MP745U M1: KDC-X8016BT
M2: KDC-X8016BTL M3: KDC-X7016 M4: KDC-X7016L E1: KDC-BT60U E1: KDC-6047U

⚠ indicates safety critical components.

PARTS LIST

MECHANISM ASSY (X92-6360-04) DXM-9B30W

Ref.No.	A d d	N e w	Parts No.	Description	Dest inati on	Ref.No.	A d d	N e w	Parts No.	Description	Dest inati on
40	3B		D39-0277-15	DAMPER							
41	3B		D39-0278-15	DAMPER							
46	1B		G01-4682-34	TORSION COIL SPRING							
47	3A *		G01-4756-04	EXTENSION SPRING							
48	2A		G01-4684-04	EXTENSION SPRING							
49	2B		G01-4685-04	EXTENSION SPRING							
50	1B		G01-4686-14	EXTENSION SPRING							
51	3A		G01-4688-14	EXTENSION SPRING							
52	3A		G01-4692-24	TORSION COIL SPRING							
54	3A		G02-1588-04	FLAT SPRING							
55	1B		G13-1297-04	CUSHION							
56	1B		G13-1299-14	CUSHION							
57	1A		G16-1715-04	SHEET							
61	1B		J11-0675-03	CLAMPER							
64	2A		J19-7210-21	HOLDER							
65	2B		J19-7225-04	HOLDER							
66	1B		J22-0706-03	MOUNTING HARDWARE							
67	1A		J22-0707-12	MOUNTING HARDWARE							
68	1B		J90-1166-11	GUIDE							
69	2B		J90-1168-03	RAIL							
A	1A		N09-6108-15	TAPTITE SCREW (M2X3.5)							
B	2B		N09-6426-15	MACHINE SCREW							
C	2B		N09-6735-05	TAPTITE SCREW							
D	2B		N09-6737-15	MACHINE SCREW							
E	2B		N09-6738-15	TAPTITE SCREW							
F	2A		N19-2335-14	FLAT WASHER							
G	2B		N35-2003-48	BINDING HEAD MACHINE SCREW							
H	2B		N39-1720-48	PAN HEAD MACHINE SCREW							
76	2A		S68-0921-05	PUSH SWITCH							
DM1	2B		X94-2090-00	SPINDLE MOTOR ASSY							
DM2	2B		X94-2100-00	FEED MOTOR ASSY (LOAD/SLED)							
DPU1	2B		X93-2280-00	OPTICAL PICKUP ASSY							

K: KDC-X994 K1: KDC-BT945U K2: KDC-X794 K3: KDC-MP745U M1: KDC-X8016BT
M2: KDC-X8016BTL M3: KDC-X7016 M4: KDC-X7016L E1: KDC-BT60U E1: KDC-6047U

 indicates safety critical components.